

KRAZE[®]
MODULAR SWITCHES



KOLORS[®] | MAKE LIFE™
BETTER



MAKE LIFE
BETTER



Life's good when it gets better with time and times are changing. It is the Green Age and we at Kolors are environment conscious corporate citizens committed to provide you with quality products; reduce the carbon footprint and be an equal opportunity employer. We are constantly improving our products and services as per the changing needs of our consumers. By 'Make life better' we mean better technology, better features, better products and better possibilities. Everyone wants to make their life better, and Kolors does exactly that for them. Our company has state-of-the-art manufacturing facilities at multiple locations in India. It is supported by a full-fledge in-house product development division which is constantly innovating and improving various products, processes and their safety features.

Kraze modular switches are created from lexan grade polycarbonate raw material. They have a distinct advantage of being fire retardant, impact resistant and stabilize ultra violet rays preventing the products colours from fading. These modular switches blend beautifully with any decor. Their stunning colours and fascinating finishes are designed to create the perfect ambience. Every component that goes into product form is precision engineered to ensure long life and trouble free operations. For the past 40 years, Kolors has endeavoured to bring you the best products and designs in the field. Our consistent performance has seen the Kolors brand attain a leading position in the market. Our growing portfolio of innovative products and designs promises to make life so much better.



SWITCH TECHNICAL

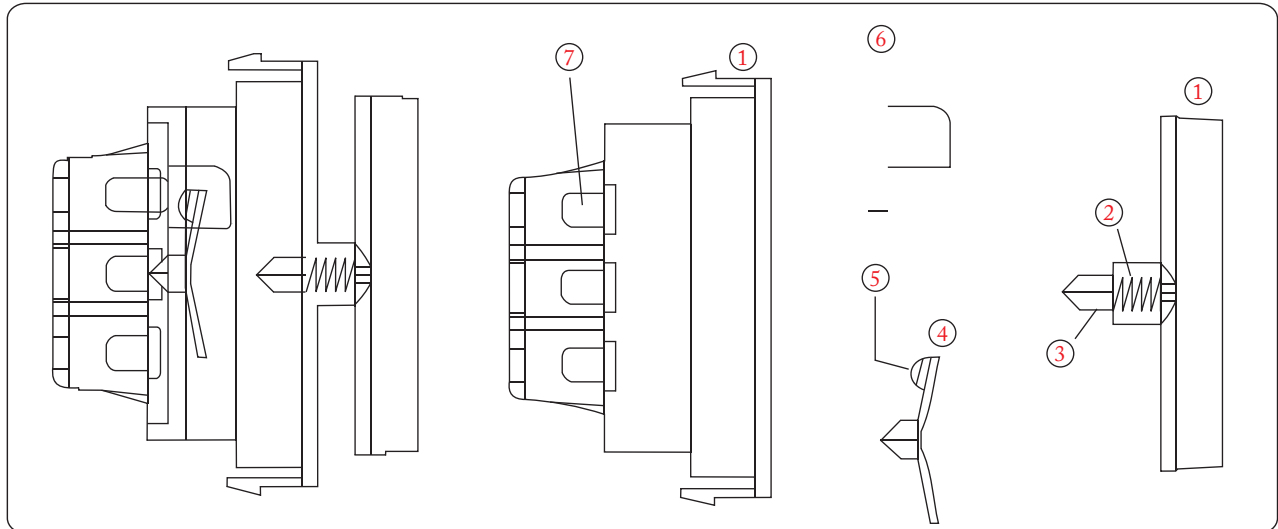

- | | |
|--|--|
| <ol style="list-style-type: none"> 1. Switch Body & Knob (FR Grade Polycarbonate) 2. S. S. Spring 3. Rocker actuator (Glass Filled Nylon 66) 4. Jhula / Rocker arm (Phosphorus Bronze for High Conductivity) | <ol style="list-style-type: none"> 5. Bi-Metal Silver Cadmium Oxide (AgCdO) Rivet for High Conductivity 6. Spark Shield for concealing high sparking 7. Silver Plated Brass Terminal for higher conductivity. |
|--|--|

ISI MARKED SWITCHES WITH CE MARKING

- Design : Design "A" (Piano as well as mega switches) with IPX0 rating
- Type of fittings : To be fitted in Flush type mounting Modular Plates
- Mechanism : Rocker
- Ratings : 6A, 16A, 10AX, 20A, 32A (240V 50Hz) & 6A 240V 50Hz for momentary contact switches
- Insulation Resistance : More than 2000 Mega Ohm (completely shock proof)

SWITCH FEATURES

- Electro mechanical endurance: more than 1,00,000 electro mechanical operation.
- Material for rocker arm: electrolytic copper with Electroplated silver.
- AX Rated switches could be used for florescent lamps.
- Ergonomic design mechanism ensures effortless, noise free operation.
- Low voltage drop, low temperature rise in metal parts.
- Specially designed arc shield (arc chamber) switches with double cap mechanism.
- All components used are compliant to RoHS (Restriction of Hazardous substance) standards.
- Nylon 66 glass filled used in actuator, which is in direct contact with conductive parts, for long operational life.

SOCKET TECHNICAL

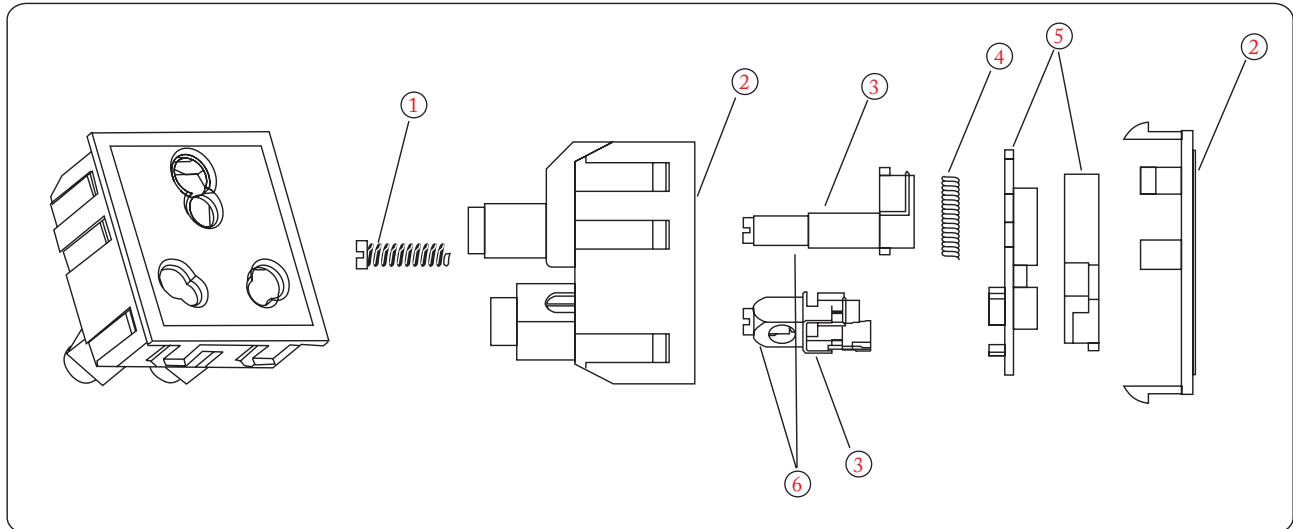

- | | |
|---|--|
| 1 Self Tapping Screw | 5 Safety Shutter (FR grade) for Safety and protection against electric shock |
| 2 Socket Body Base & Cover (FR Grade Polycarbonate) | 6 Silver plated brass terminal for higher conductivity |
| 3 Brass & Bronze " L, N & E" Part For High Conductivity | |
| 4 S.S. Spring | |

SOCKET (SINGLE & MULTI RATED OUTLETS) WITH ISI MARK

- Design : Design A with IPX0 rating.
- Type of fittings : To be fitted in Flush type mounting on modular plates.
- Rating : 6A (two in one), 16A, 6A-16A, 6A-10A-13A (Multi purpose), 25A (240V 50Hz)
(Except for shaver socket which comes with two rating outlets in one 110 V and 240 V).
- Creep age distance : 19.82 to 19.86 mm
- Clearance distance : 19.82 to 19.86 mm
- Water absorptions in insulating material : 1.22%.
- Withdrawal pull required : 6 A - 32 to 36 N & 16 A - 46 to 51 N

SOCKET FEATURES

- 6A (two in one socket)- Accepts two Pin plugs (Thin Pin for mobile chargers only), with solid brass contacts.
- 6A-10A-13A- multi -purpose socket- with independent safety shutters for two pin and three pin, accepts both flat as well round plug pin.
- 6A-16A 240V AC- with safety shutter operational by earthing pin only, only round plugs accepted by socket outlets.
- 16A, 240 V AC-with safety shutters operational by earthing pin only (first in last out), only round Pin accepted by socket outlet.



**Shown here is 8 Module (Horz.) cover frame
with 6 Amp. 1 Way Switch in Matte Black finish**



Kraze modular switches blend beautifully with any décor. Their stunning colours and fascinating finishes are designed to create the perfect ambience, be it for your home or your office.

SALIENT FEATURES

- Greener Product For Green Buildings- Rohs Compliant With ISI & CE.
- Thermoplastic (polycarbonate) with excellent finish.
- All brass/copper components have electroplated silver layer for good conductivity.
- Dedicated hospitality and data communication range.
- Accessories are mounted on inner plates with changeable cover frames which comes in different shades.
- The inner plates can be mounted on concealed as well as surface enclosures.
- These fittings are suitable for all kind of standard Boxes.
- Created from Lexan grade Polycarbonate raw material, Kraze modular switches have the distinct advantage of being fire-retardant and impact resistant.
- Every component that goes into its production is precision engineered to ensure long life and trouble free operations.



DIMMER FOR LIGHT CONTROLS

- To be used for incandescent lamps light control only, not to be used for CFL lamp light control
- Load : 400 watts
- Up to 10000 electromechanical cycles
- Output voltage- 12 V-230 V A.C only





















STEP REGULATOR

- 360 degree full rotation (clockwise) with hum free operation
- Saves energy up to 40%
- To be used in 100 to 120 Watt fans only
- Operational voltage should be from 230 V to 240V at 50Hz
- Operational temperature should be 27°- 40° Celsius
- Upto 2.5 sq mm. wire to be used





DOWN LIGHT

- Source of light : Three led's with cool white light
- Power consumed : 1.5 watts
- Input required : 240V 50 Hz

				Cat No White	Cat No Black	Particulars	Pkg	
   				6 Amps. K-10 Switches				
KK-1001	KK-1002	KK-1003	KK-1005	KK-1001	KK-1001 MB	6 A 1 Way Switch	20	
				KK-1002	KK-1002 MB	6 A 2 Way Switch	20	
				KK-1003	KK-1003 MB	6 A Bell Push	20	
				KK-1004	KK-1004 MB	6 A 1 Way Switch with Neon	20	
				KK-1005	KK-1005 MB	6 A Bell Push with Neon	20	
  				16 Amps. K-10 Switches				
				KK-1006	KK-1006 MB	16 A 1 Way Switch	20	
				KK-1007	KK-1007 MB	16 A 2 Way Switch	20	
				KK-1008	KK-1008 MB	16 A 1 Way Switch with Neon	20	
   				6 Amps. K-10 Plus Switches				
KK-1009	KK-1010	KK-1011	KK-1013	KK-1009	KK-1009 MB	6 A 1 Way Switch	10	
				KK-1010	KK-1010 MB	6 A 2 Way Switch	10	
				KK-1011	KK-1011 MB	6 A 1 Way Switch with Neon	10	
				KK-1012	KK-1012 MB	6 A Bell Push	10	
				KK-1013	KK-1013 MB	6 A Bell Push with Neon	10	
   				16 Amps. K-10 Plus Switches & 32 Amps. D. P. Switch				
KK-1014	KK-1015	KK-1016	KK-1017	KK-1014	KK-1014 MB	16 A 1 Way Switch	10	
				KK-1015	KK-1015 MB	16 A 2 Way Switch	10	
				KK-1016	KK-1016 MB	16 A 1 Way Switch with Neon	10	
				KK-1017	KK-1017 MB	32 A D. P. Switch with Neon	10	
   				6 Amps. & 16 Amps. Sockets				
KK-1018	KK-1019	KK-1019-A	KK-1020	KK-1018	KK-1018 MB	6 A 2 Pin Socket with Safety Shutter	20	
				KK-1019	KK-1019 MB	6 A 2-in-1 Socket with Safety Shutter	10	
				KK-1019-A	KK-1019-A MB	6 A 3 Pin Socket with Safety Shutter	10	
				KK-1020	KK-1020 MB	16 A 3 Pin Socket with Safety Shutter	10	

				Cat No White	Cat No Black	Particulars	Pkg	
				6/10/13/16/25 Amps. Sockets & Shaver Socket				
KK-1021	KK-1022	KK-1022-B	KK-1023	KK-1021	KK-1021 MB	6/16 A Universal Socket with Safety Shutter	10	
				KK-1021-A	KK-1021-A MB	25 A Universal Socket with Safety Shutter	10	
				KK-1022	KK-1022 MB	6/10/13 A Multipurpose (Intl.) Socket with Safety Shutter (Suitable for all plug pins)	10	
				KK-1022-B	KK-1022-B MB	6/10/13 A Multi Socket with Safety Shutter	10	
				KK-1023	KK-1023 MB	110/240 V Shaver Socket** with Safety Shutter	10	
				Fan Dimmers & Regulators				
KK-1024	KK-1025	KK-1026	KK-1042-A	KK-1024	KK-1024 MB	Mini Dimmer 450 W	10	
				KK-1025-A	KK-1025-A MB	Medium Dimmer 450 W	10	
				KK-1025-B	KK-1025-B MB	Medium Dimmer 650 W **	10	
				KK-1026	KK-1026	Mini Fan Step Regulator [Full Rotation]	10	
				KK-1042-A	KK-1042-A MB	Medium Fan Step Regulator [Full Rotation]	10	
				Cord Outlet, T.V. Antenna Socket & Telephone Jack				
KK-1030	KK-1031	KK-1033	KK-1034	KK-1030	KK-1030 MB	Cord Outlet with Grip	20	
				KK-1031	KK-1031 MB	T.V. Antenna Socket	20	
				KK-1033	KK-1033 MB	Mini 2 Line Telephone Jack with Shutter	20	
				KK-1034	KK-1034 MB	Mini 4 Line Telephone Jack	10	
				Support Modules				
KK-1037	KK-1038	KK-1039	KK-1040	KK-1037	KK-1037 MB	Mini Blanking Plate	40	
				KK-1038	KK-1038 MB	Medium Blanking Plate	20	
				KK-1039	KK-1039 MB	10 & 16 Amps. Kit Kat Fuse	10	
				KK-1040	KK-1040 MB	Neon Indicator	20	
				KK-1041	KK-1041 MB	Mosquito Repellent** [Use with Matt]	10	
				KK-1042	KK-1042 MB	Night Lamp with Led.	10	
				KK-1042-C	KK-1042-C MB	Skirting Light with Led.	10	

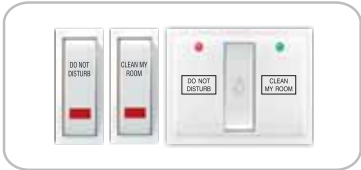
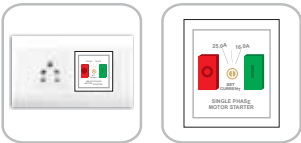
		Cat No White	Cat No Black	Particulars	Pkg	
 KK-1035-A KK-1035-B						
Computer Jacks						
		KK-1035-A	KK-1035-A MB	Mini RJ 45 Modem Jack For Computer Lucent [CAT-5] [AT & T] with Shutter	10	
		KK-1035-B	KK-1035-B MB	Mini RJ 45 Modem Jack For Computer Lucent [CAT-6] [AT & T] with Shutter	10	
Hotel & Hospitality Key Tag & Modular MCB						
			KK-1044	KK-1044 MB	32 Amps. D.P. Mains On-Off with Key Tag Operating & Power Saving	05
			KK-1045	KK-1045 MB	Only Key Tag with Key Ring	05
			KK-1046	KK-1046 MB	Single Pole MCB 6A, 10A, 16A, 20A, 25A, 32A	10
			KK-1047	KK-1047 MB	Double Pole MCB 6A, 10A, 16A, 20A, 25A, 32A	10
 KK-1044 KK-1045 KK-1046 KK-1047						
Down Light, Bell Indicator & Buzzer						
			KK-1032	KK-1032 MB	Down Light 4 Module Cover Frame with Concealed G. I. Metal Box Arranged For Lamp Holder	05
			KK-1032-B	KK-1032-B MB	Only Cover Frame	10
			KK-1032-C	KK-1032-C MB	Down Light 4 Module Cover Frame with Led	05
			KK-1051	KK-1051 MB	Bell Indicator for Office & Hospital etc.	10
			KK-1053	KK-1053 MB	Medium Electronic Buzzer ** 220 V / 240 V	10
 KK-1032 KK-1051 KK-1053						
Room Service Switches & Bell Push Unit						
			KK-1043	KK-1043 MB	Complete Unit of 2 Switches & 1 Bell Push / Neon **	05
 KK-1043						
Single Phase Motor Starter Switch						
			KK-1049-A	KK-1049-A MB	Complete Unit of Single Phase Motor Starter & 25A Socket with 4 Module Plate & Surface Box [5 HP]	05
			KK-1050	KK-1050 MB	Single Phase Motor Starter 240V 50Hz	10
 KK-1049-A KK-1050						

Product with ** mark will be available within 4 to 6 weeks after receiving purchase order.

RANGE OF COVER FRAMES

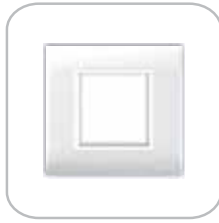

Gloss / Pearl

Code	Module Size	Pkg
KK-2001	1	10
KK-2002	2	10
KK-2003	3	10
KK-2003-A	3 / Alternate	10
KK-2004	4	10
KK-2005	6	10
KK-2006	8 (Horz.)	10
KK-2009	8 (Square)	5
KK-2007	12	5
KK-2010	16	5
KK-2008	18	5

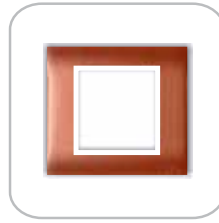

Metallic / Matt

Code	Module Size	Pkg
KK-3001	1	10
KK-3002	2	10
KK-3003	3	10
KK-3003-A	3 / Alternate	10
KK-3004	4	10
KK-3005	6	10
KK-3006	8 (Horz.)	10
KK-3009	8 (Square)	5
KK-3007	12	5
KK-3010	16	5
KK-3008	18	5

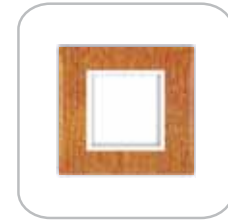

Texture / Two-Tone / Stipple

Code	Module Size	Pkg
KK-4001	1	10
KK-4002	2	10
KK-4003	3	10
KK-4003-A	3 / Alternate	10
KK-4004	4	10
KK-4005	6	10
KK-4006	8 (Horz.)	10
KK-4009	8 (Square)	5
KK-4007	12	5
KK-4010	16	5
KK-4008	18	5

MODULE MOUNTING FRAME

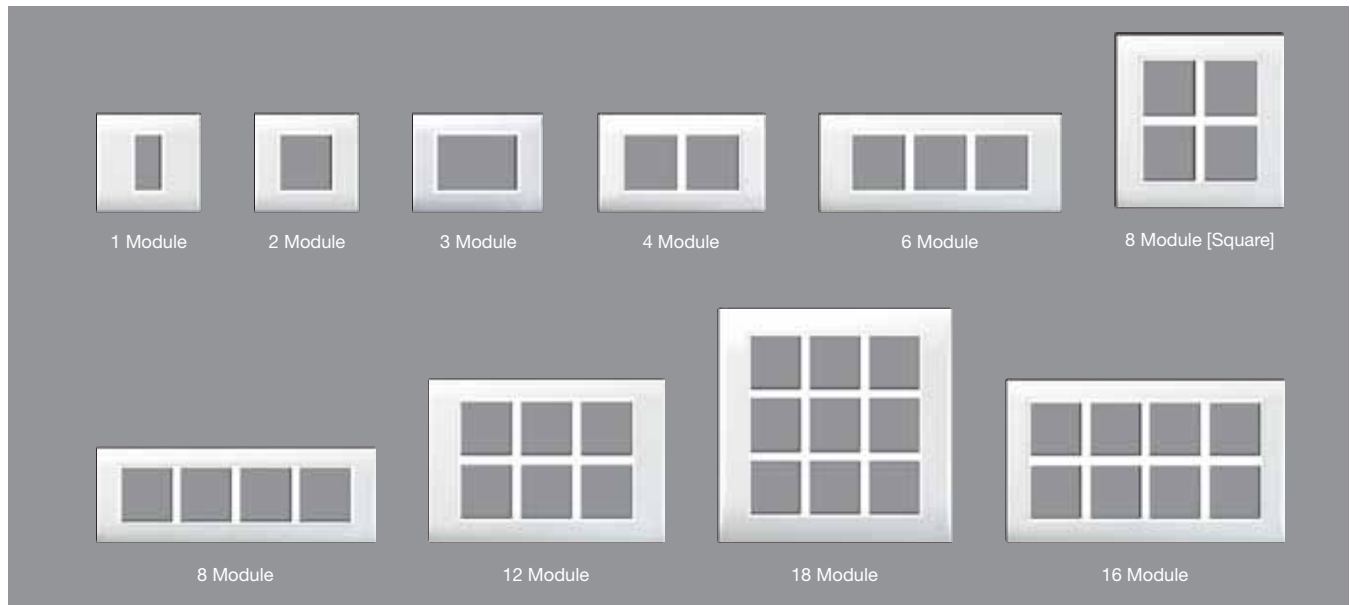

Kindly refer to Kolors Modular Boxes Price List cum Catalogue for Flush Metal / Surface unbreakable / Flush unbreakable Boxes .

Available Colours

GLOSS / PEARL

WHITE | IVORY

METALLIC / MATT

METALLIC COPPER | MATT BLACK | MATT WOOD

TEXTURE / TWO TONE

TEAK WOOD | LIGHT OAK | GOLDEN TEX. WOOD | BROWN TEX WOOD | DIGITAL TEX WOOD | DARK OAK | LACQUER SILVER



White



Ivory



Metallic Copper



Matt Black



Matt Wooden



Teak Wood



Light Oak



Golden Tex Wood



Brown Tex Wood



Digital Tex Wood



Dark Oak



Lacquer Silver

Disclaimer :

- The print process does not allow for exact reproduction of the paint colour, print & finishes
- Colours & Finishes are liable to change without any prior notice
- If Cover Frame colours in this brochure may not be readily available with the company / distributor / Dealer (in that case a minimum of 21 working days will be required to deliver the same)
- Colour may vary lot to lot due to environmental / climatic / temperature etc. which are beyond co's control
- Kolors logo is trademark & property of Kolors company
- Misuse of any intellectual property, or any other content displayed here in is strictly prohibited



WHAT'S NEXT?

At Kolors, we believe in constantly challenging ourselves to improve our products and services as per the changing needs of our consumers; i.e. you. We believe in developing better technology, better products and better possibilities that reflect and meet your urban lifestyle. We want to ensure you get your money's worth by providing you with options and choices in design, colour, material, functionality and price.

Kolors – Products and Designs that Make Life Better.





Guarantee

- The Company undertakes to replace or repair products at its discretion should it become defective solely as a result of faulty materials or workmanship within 10 (Ten) years for Switches (without Neon) & Power Sockets. For all other Kolors Kraze products the guarantee will be for 1(One) year only. No guarantee on cover frames.
- The above guarantee is applicable only when the products are installed in Kolors Flush Metal / Surface PVC / Flush PVC Boxes.
- The Guarantee will be invalid if the product has not been installed or maintained in accordance with the Company's instruction, or if any attempts has been made to rectify, dismantle or alter the product.
- The Company reserves the right to modify or change the product design and specification in the future without prior notice.
- The Guarantee does not extend to cover consequential loss or damage or installation costs arising from the defective product.
- All Kolors Kraze Modular Switches & Accessories are mfg. from polycarbonate resins.



COSMO ELECTRO INDUSTRIES PVT. LTD.
522, Laxmi Plaza, Laxmi Industrial Estate,
Off. Link Road, Andheri (W), Mumbai - 400 053
Customer Care Ph.: [022] 26311476
www.kolorsswitches.com - e-mail:sales@kolorsswitches.com